

PORTFOLIO

JATUPOL JAIYAI
ARCHITECTURE & INTERIOR



R.I.S DANIEL INTERNATIONAL SCHOOL PROJECT

LOCATION : AMPHOE MUEANG SURAT THANI, SURAT THANI

COMPANY : CHAPOH DESIGN STUDIO

AREA : 7,663 sq.m.

ROLE IN PROJECT

- SUPPORT DESIGN TEAM ARCHITECTURE
- DESIGN MAIN HALL (LIBRARY HALL)
- 3D MODEL & RENDER PERSPECTIVE
- PERSENTATION



ARCHITECTURE & INTERIOR

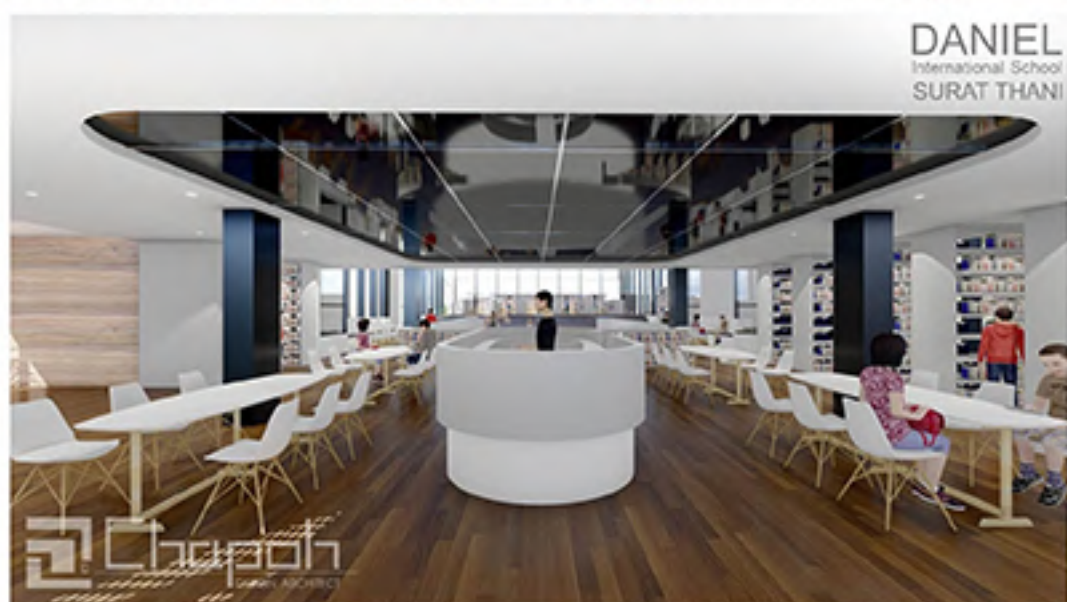
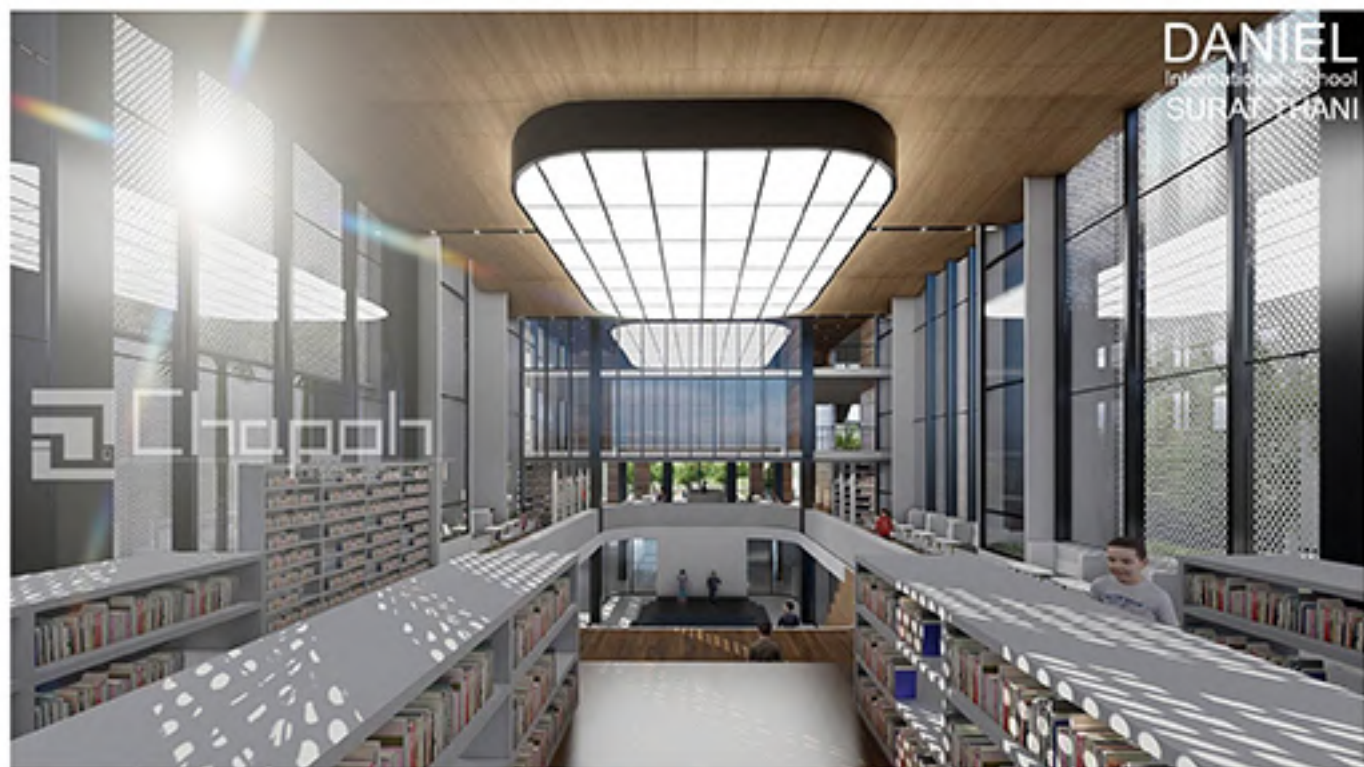

RENOVATION NAVATANEE HOUSE

LOCATION : KHAN NA YAO, BANGKOK

COMPANY : CHAPOH DESIGN STUDIO

AREA : - sq.m.

ROLES & RESPONSIBILITIES IN PROJECT

- SUPPORT DESIGN TEAM ARCHITECTURE & INTERIOR
- DESIGN 2nd Floor (MASTER BEDROOM, BEDROOM 1, BEDROOM2, WALK IN CLOSET)
- DESIGN 3rd Floor (LIVINGROOM, WALK IN CLOSET, BEDROOM3)
- 3D MODEL & RENDER PERSPECTIVE INTERIOR
- SUPPORT DRAWING ARCHITECTURE & INTERIOR
- PERSENTATION

ARCHITECTURE



OLD DESIGN



NEW DESIGN

INTERIOR



MASTERBEDROOM



BEDROOM 2



BEDROOM 3



LIBRARY ROOM
ARCHITECTURE & INTERIOR

INTERIOR



DRAWING

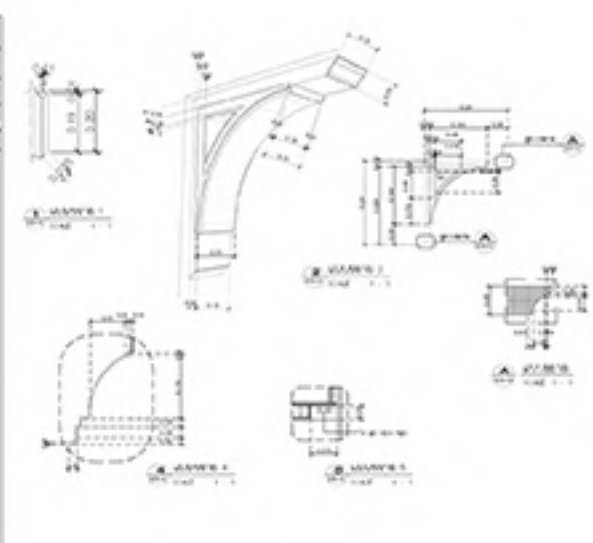
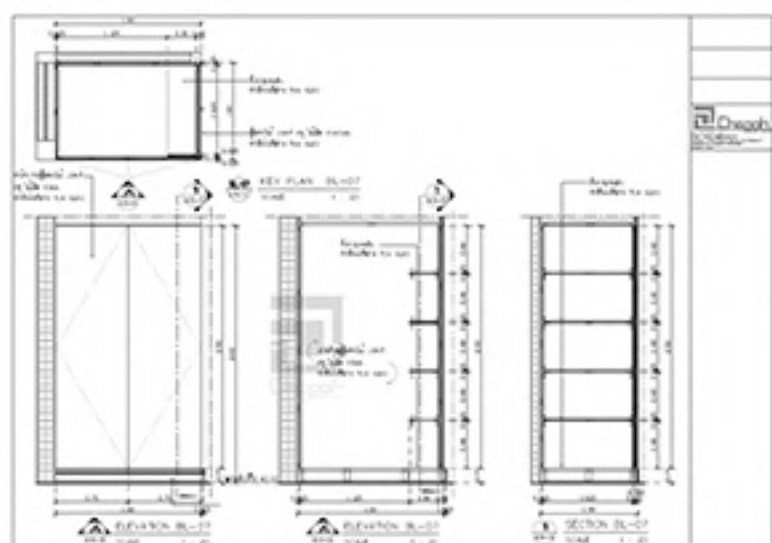
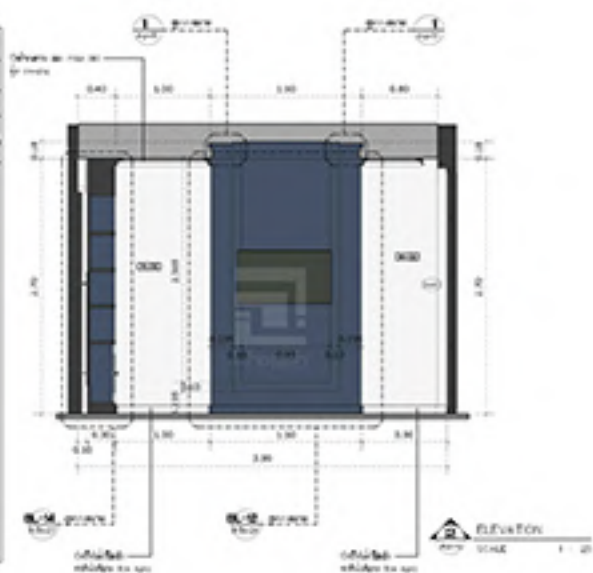

KIDS TEUNG CAFE

LOCATION : SAM PHRAN, NAKHON PATHOM

COMPANY : CHAPOH DESIGN STUDIO

AREA : - sq.m.

ROLES & RESPONSIBILITIES IN PROJECT

- SUPPORT DESIGN TEAM ARCHITECTURE & LANDSCAPE
- SUPPORT DRAWING ARCHITECTURE & LANDSCAPE
- 3D MODEL FOR CHECK ON SITE
- WORK ON SITE

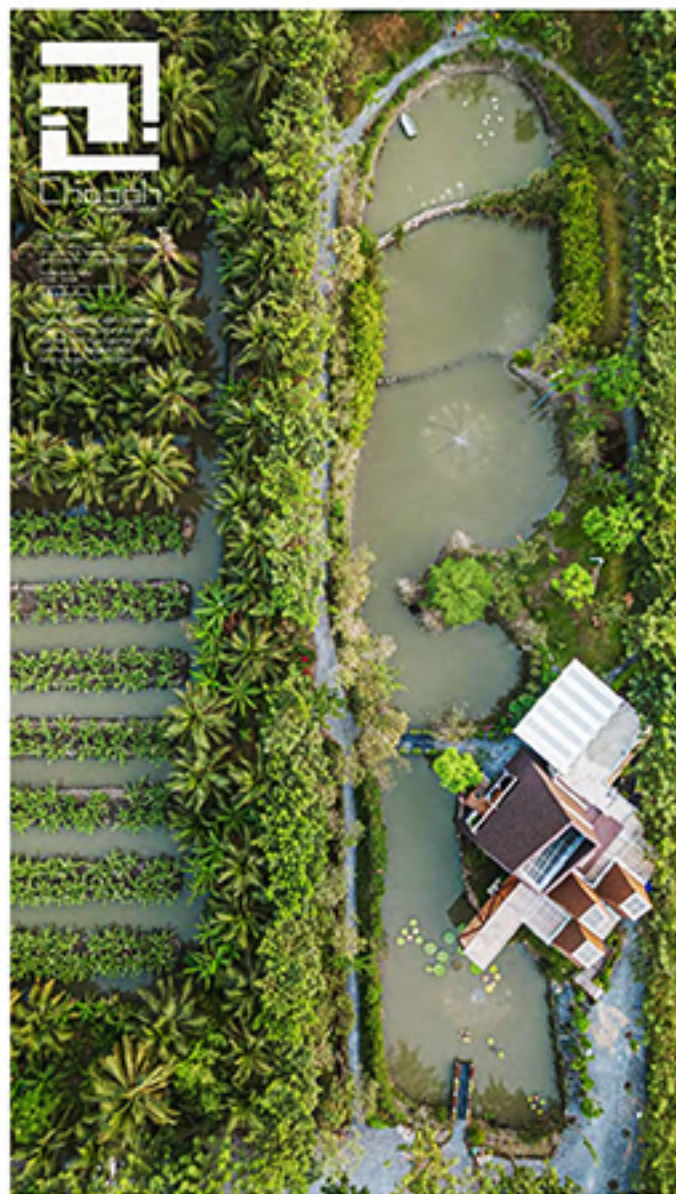
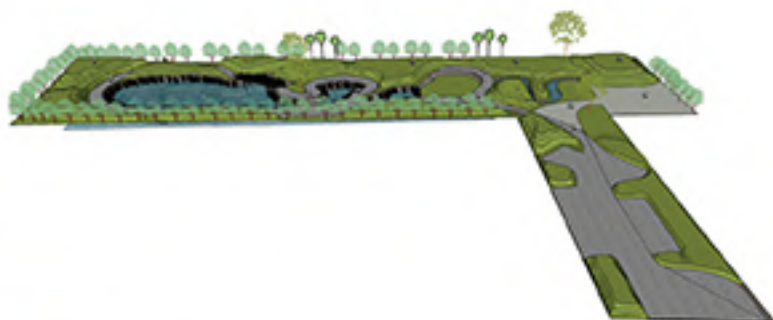

DRAWING

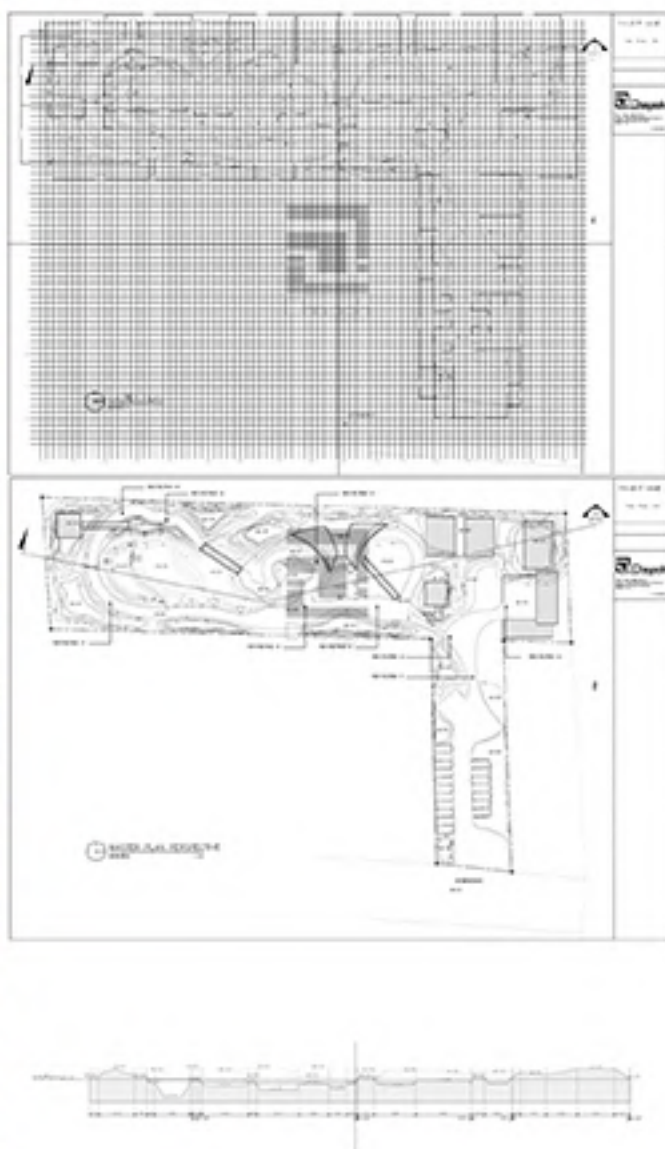

ON SITE



ARCHITECTURE & LANDSCAPE

BAAN K'MHAI

LOCATION : CHIANG MAI

COMPANY : CHAPOH DESIGN STUDIO

AREA : - sq.m.

ROLES & RESPONSIBILITIES IN PROJECT

- SUPPORT DESIGN TEAM ARCHITECTURE
- SUPPORT 3D ARCHITECTURE & RENDER
- CHECK ON SITE

DRAWING

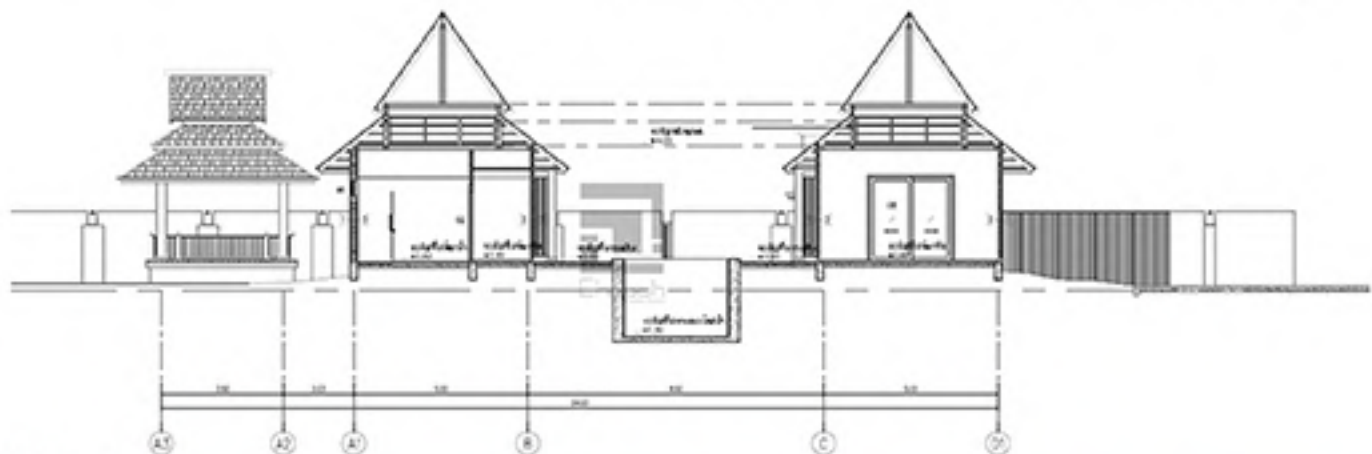

PERSPECTIVE



ARCHITECTURE

RENOVATION FACTORY

LOCATION : TAWEEWATTANA, BANGKOK

COMPANY : CHAPOH DESIGN STUDIO

AREA : - sq.m.

ROLES & RESPONSIBILITIES IN PROJECT

- DESIGN ARCHITECTURE
- 3D MODEL & RENDER
- DRAWING ARCHITECTURE

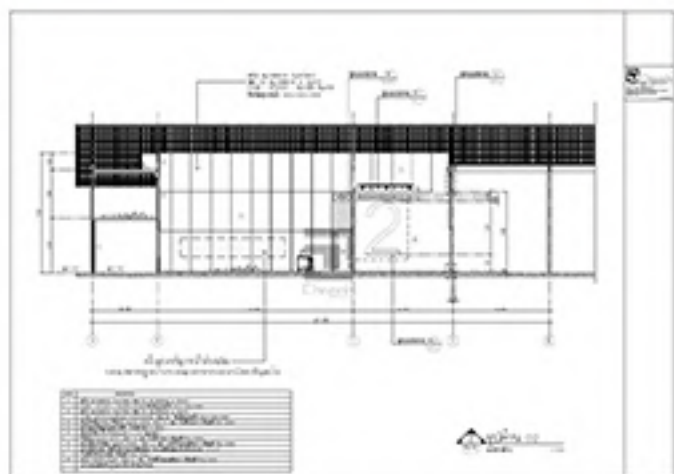
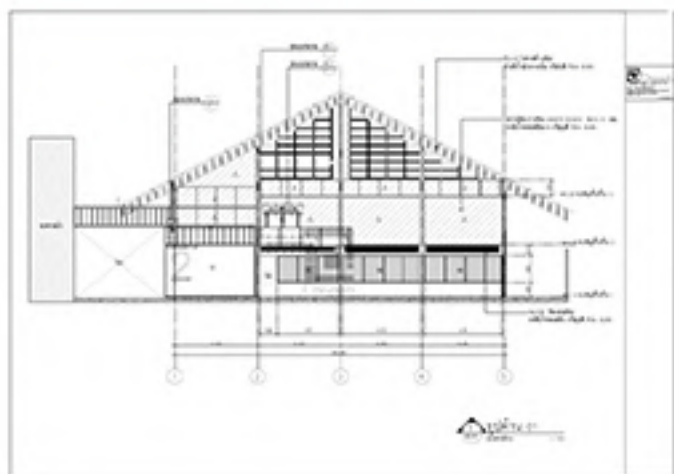

T IN TYME CAFE

LOCATION : CHON BURI

COMPANY : CHAPOH DESIGN STUDIO

AREA : 130 sq.m.

ROLES & RESPONSIBILITIES IN PROJECT

- DESIGN INTERIOR DESIGN
- 3D MODEL & RENDER
- SUPPORT TEAM DRAWING INTERIOR
- SPEC MATERIAL
- MEASURE ON SITE



INTERIOR

GRAND BANGKOK BOULERVARD 01

LOCATION : BANG-KAPI, BANGKOK

COMPANY : CHAPOH DESIGN STUDIO

AREA : - sq.m.

ROLES & RESPONSIBILITIES IN PROJECT

- DESIGN INTERIOR 1ST FLOOR & 2ND FLOOR
- 3D MODEL & RENDER
- SPEC MATERIAL
- SUPPORT DRAWING INTERIOR
- MESURE ON SITE



INTERIOR



DRAWING

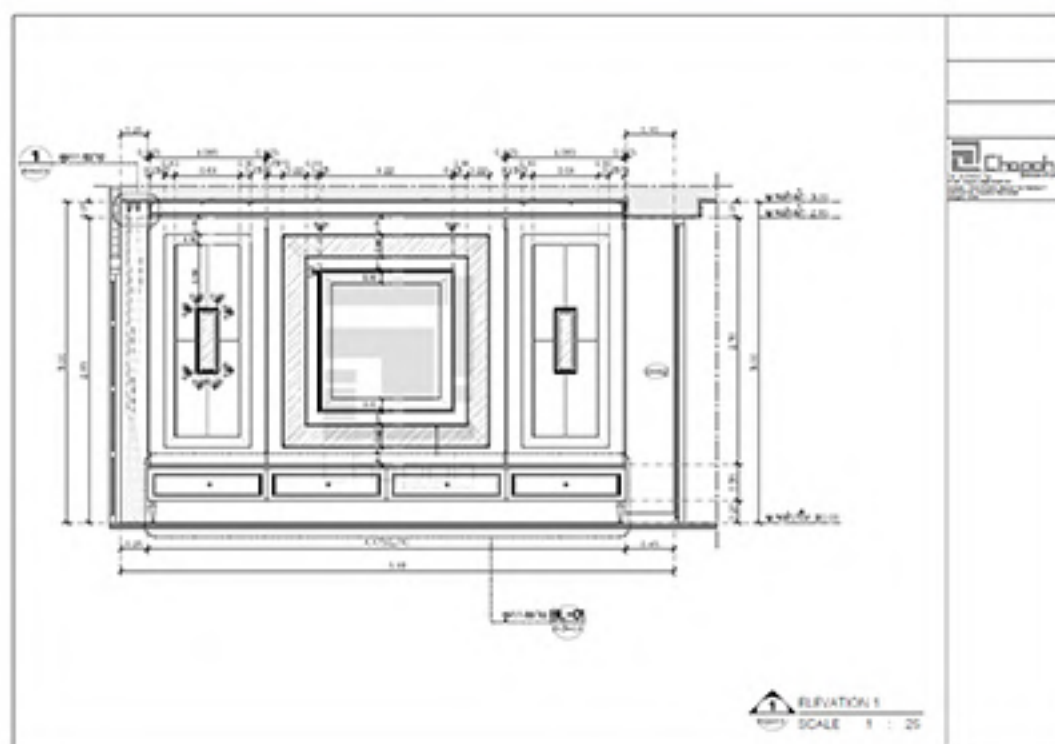

GRAND BANGKOK BOULERVARD 02

LOCATION : BANG-KAPI, BANGKOK

COMPANY : CHAPOH DESIGN STUDIO

AREA : - sq.m.

ROLES & RESPONSIBILITIES IN PROJECT

- DESIGN INTERIOR 2ND FLOOR
- 3D MODEL & RENDER
- SPEC MATERIAL
- SUPPORT DRAWING INTERIOR
- MESURE ON SITE



BAAN K'WICHIT

LOCATION : RAMKUMHAENG, BANGKOK

COMPANY : CHAPOH DESIGN STUDIO

AREA : - sq.m.

ROLES & RESPONSIBILITIES IN PROJECT

- DESIGN INTERIOR 1ST FLOOR & 2ND FLOOR
- 3D MODEL & RENDER
- SPEC MATERIAL



BAAN SAI 2 TYPE A & B

LOCATION : TAWEEWATTANA, BANGKOK

COMPANY : CHAPOH DESIGN STUDIO

AREA : - sq.m.

ROLES & RESPONSIBILITIES IN PROJECT

- DESIGN INTERIOR TYPE A 2ND FLOOR (BEDROOM 1-5, WALK IN CLOSET, PAY ROOM)
- DESIGN INTERIOR TYPE B 2ND FLOOR (BEDROOM 2-4)
- 3D MODEL & RENDER
- SPEC MATERIAL
- MESURE ON SITE

TYPE A



TYPE B



BAAN K'GIFF

LOCATION : AMPHOE MUEANG, NAKHON SAWAN

COMPANY : ARTHI DESIGN STUDIO

AREA : 60.50 sq.m.

ROLES & RESPONSIBILITIES IN PROJECT

- DESIGN INTERIOR 1ST FLOOR (LIVING ROOM, PANTRY ,LAUNDRY ROOM)
- DESIGN INTERIOR TYPE B 2ND FLOOR (MASTER BEDROOM)
- 3D MODEL & RENDER
- SPEC MATERIAL
- MESURE ON SITE

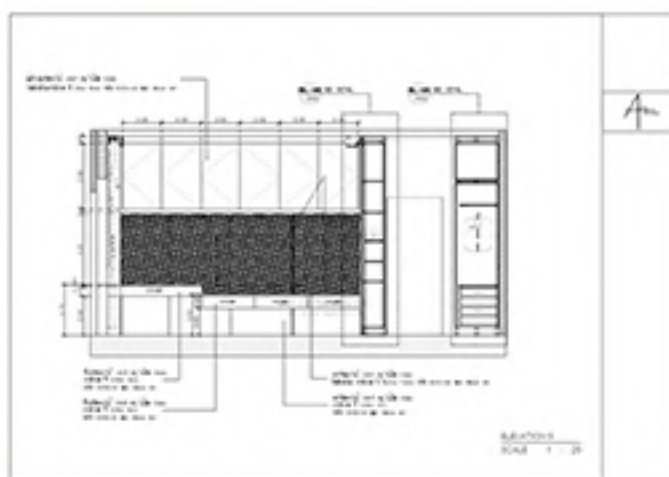

TUNSUB ACCOUNTING HOME OFFICE

LOCATION : DOEM BANG NANG BUAT, SUPHAN BURI

COMPANY : ARTHI DESIGN STUDIO

AREA : 299 sq.m.

ROLES & RESPONSIBILITIES IN PROJECT

- DESIGN RENOVATION ARCHITECTURE
- DESIGN INTERIOR OFFICE AND BEDROOM
- 3D MODEL & RENDER
- SPEC MATERIAL
- CHECK ON SITE



K'BLESS ROOM PRUKSA THE RESERVE PHAHOL

LOCATION : PHAYA THAI, BANGKOK

COMPANY : ARTHI DESIGN STUDIO

AREA : 21 sq.m.

ROLES & RESPONSIBILITIES IN PROJECT

- DESIGN INTERIOR BEDROOM
- 3D MODEL & RENDER
- SPEC MATERIAL
- CHECK ON SITE



INTERIOR

BAAN K' KENG LOIE

LOCATION : AMPHOE MUEANG, LOIE
COMPANY : ARTHI DESIGN STUDIO
AREA : 96 sq.m.

ROLES & RESPONSIBILITIES IN PROJECT

- DESIGN ARCHITECTURE
- 3D MODEL & RENDER

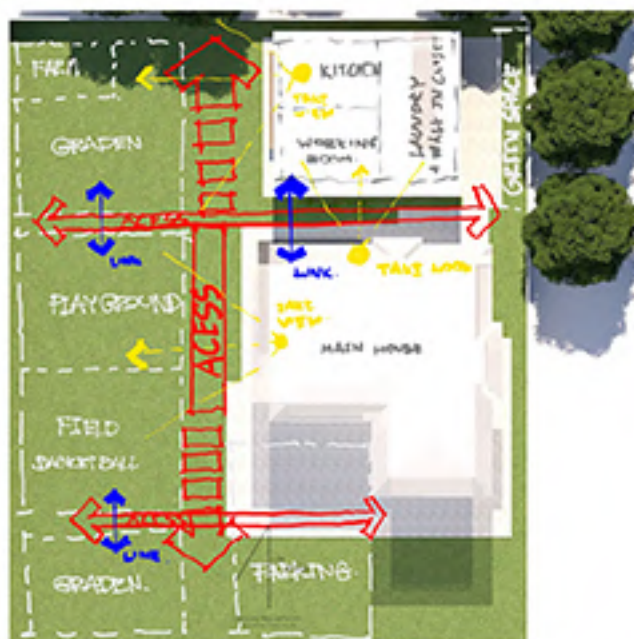

BAAN K' JOKE CHONBURI

LOCATION : AMPHOE MUEANG, CHONBURI
COMPANY : ARTHI DESIGN STUDIO
AREA : - sq.m.

ROLES & RESPONSIBILITIES IN PROJECT

- DESIGN ARCHITECTURE
- 3D MODEL & RENDER



HATO SALON

LOCATION : LAT PHRAO , BANGKOK

COMPANY : ARTHI DESIGN STUDIO

AREA : 32 sq.m.

ROLES & RESPONSIBILITIES IN PROJECT

- DESIGN INTERIOR BEDROOM
- 3D MODEL & RENDER
- SPEC MATERIAL
- CHECK ON SITE



BAAN A01

LOCATION : TAWEEWATTANA, BANGKOK

COMPANY : BY JATUPOL JAIYAI

AREA : 840 sq.m.

ROLES & RESPONSIBILITIES IN PROJECT

- DESIGN INTERIOR BEDROOM
- 3D MODEL & RENDER
- PRESENTATION



BAAN A02

LOCATION : AMPHOE MUEANG, LOIE

COMPANY : BY JATUPOL JAIYAI

AREA : 590 sq.m.

ROLES & RESPONSIBILITIES IN PROJECT

- DESIGN INTERIOR BEDROOM
- 3D MODEL & RENDER
- PRESENTATION



OUTSOURCE PROJECT

COMPANY : 33 PLUS

PROJECT : SCB CARD X

ROLES & RESPONSIBILITIES IN PROJECT

- SUPPROT DESIGN INTERIOR
- 3D MODEL & RENDER



OUTSOURCE PROJECT

COMPANY : 33 PLUS

PROJECT : RAMA HOSPITAL

ROLES & RESPONSIBILITIES IN PROJECT

- SUPPROT DESIGN INTERIOR
- 3D MODEL & RENDER
- SUPPROT DRAWIGN



OUTSOURCE PROJECT

COMPANY : 33 PLUS

PROJECT : RAMA HOSPITAL

ROLES & RESPONSIBILITIES IN PROJECT

- SUPPROT DESIGN INTERIOR
- 3D MODEL & RENDER
- SUPPROT DRAWING INTERIOR

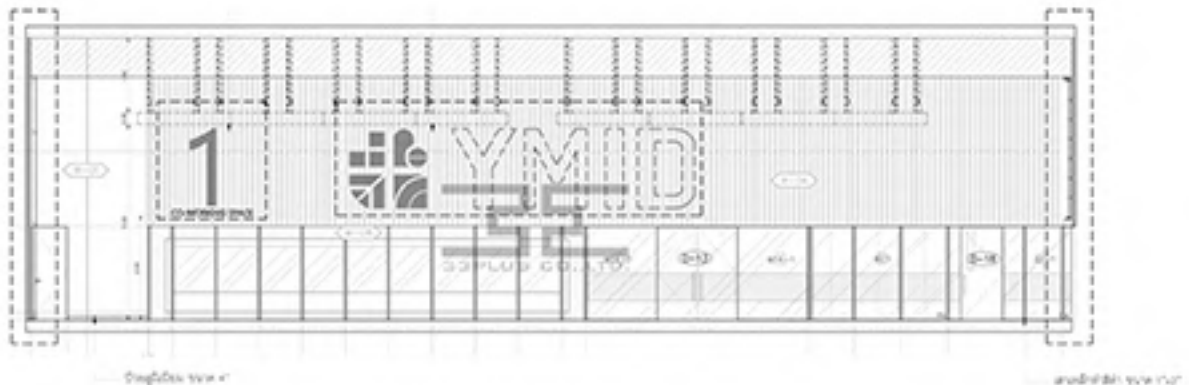
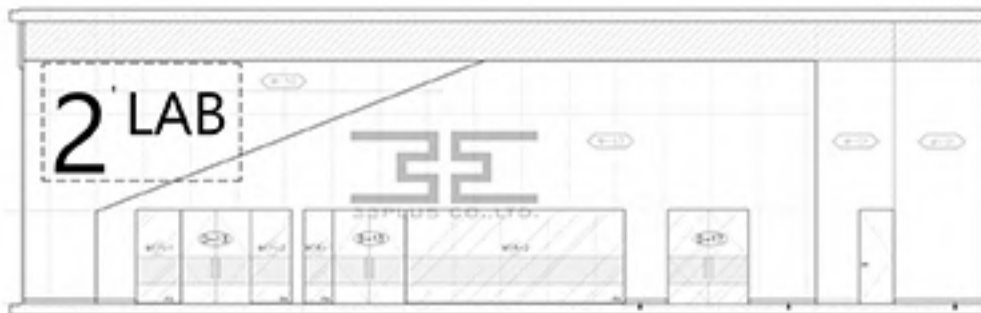
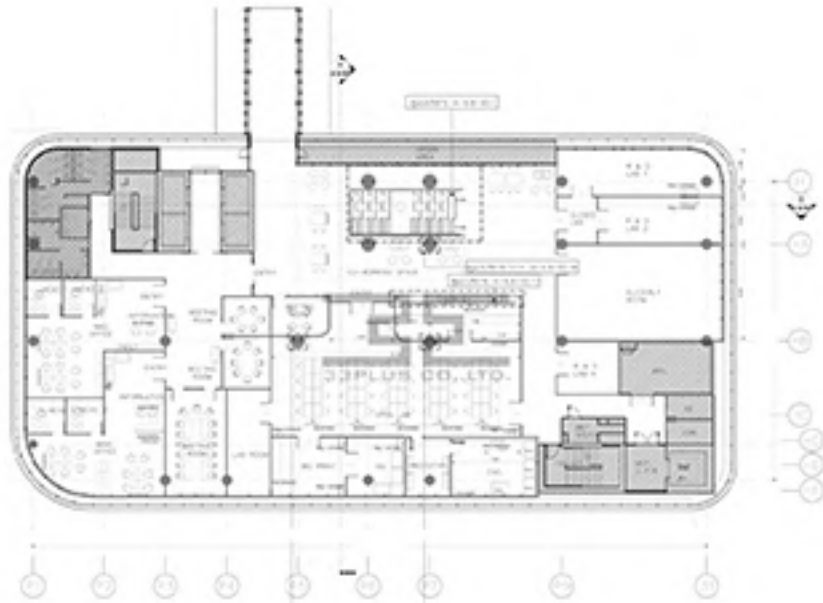

OUTSOURCE PROJECT

COMPANY : 33 PLUS
PROJECT : HOSPITAL

ROLES & RESPONSIBILITIES IN PROJECT

- SUPPROT DESIGN INTERIOR
- 3D MODEL & RENDER



OUTSOURCE PROJECT

COMPANY : 33 PLUS

PROJECT : MAYBANK

ROLES & RESPONSIBILITIES IN PROJECT

- SUPPROT DESIGN INTERIOR
- 3D MODEL & RENDER



DRAWING

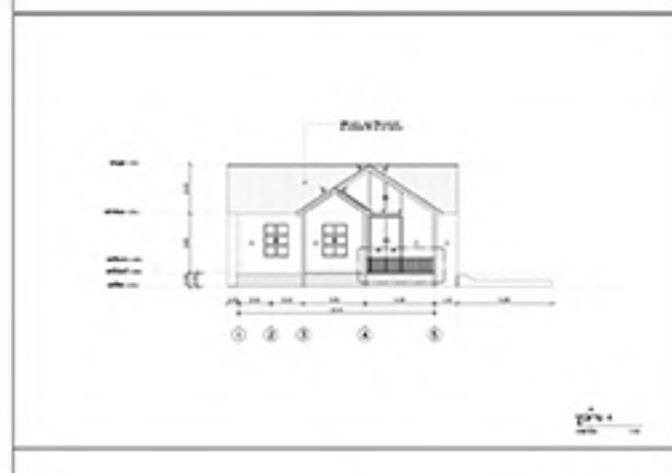
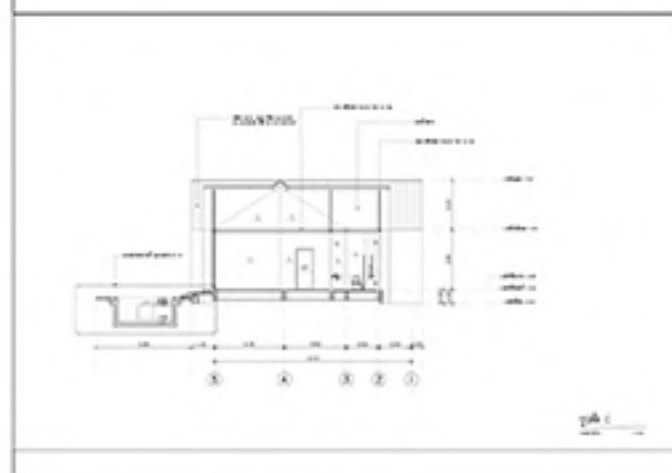
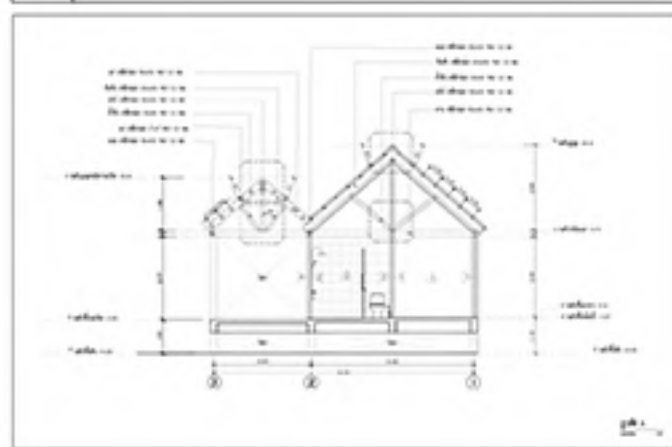
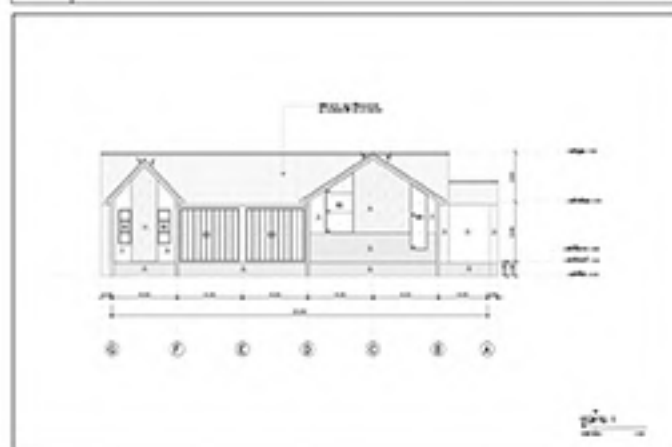
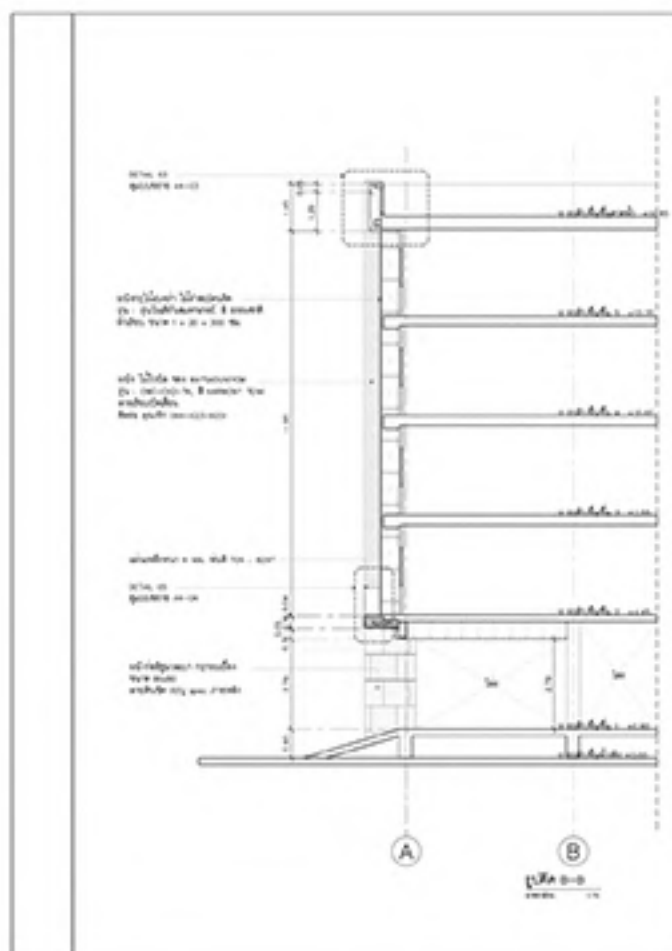
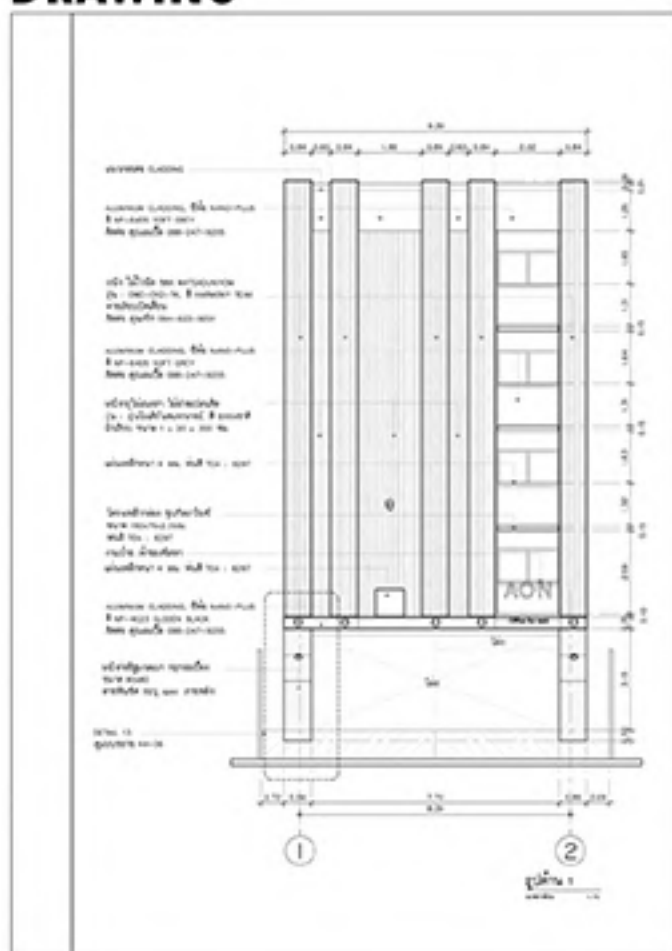

CERTIFICATE

